

Description The pneumatic proportional valve controls the outlet pressure in proportion to an electrical command input signal. It comprises a complete closed loop servo system in a compact monoblock assembly with proportional solenoid valve, electronic regulator and internal pressure transducer.

In the process, the outlet pressure is transformed into a proportional electrical signal and compared with the input signal. If the outlet pressure exceeds the preset setpoint, the valve exhausts down to the pressure desired.

The valve has no constant bleed. At absence of input signal or supply voltage the valve exhausts. The power supply of the setpoint potentiometer is provided by the proportional valve via connector pin number 5.

Pressure transducer Open transducers: 100 mbar, 500 mbar, 1 bar and vacuum

Application examples Proportional pressure regulators are being used for blowing machines, ultrasonic equipments, testing machines, painting systems, contouring systems, laser welding machines, textile machines, cheese presses, pneumatic brakes, clamping devices and medical engineering.

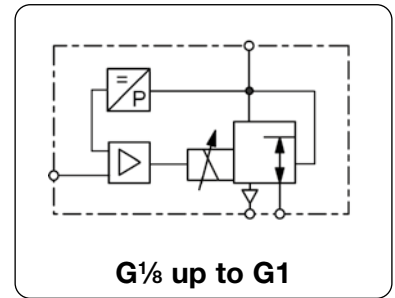

General technical features

Description 3-port/2-way valve with proportional magnet, integrated hybrid PCB and closed loop with pressure transducer in compact monoblock assembly.

Mounting position any, preferably upright

Protection class IP 54 with standard connector, IP 65 with special connector

Shock resistance 3G

Temperature range 0 °C up to 50 °C / 32 °F to 122 °F, high temperature version on request

Material Body: brass (G¹/₈) and aluminium (G¹/₄, G¹/₂ u. G1) Inner valve: brass and SST
Seals: NBR/Buna-N, on request EPDM or FKM FKM for 50 bar version

Pneumatic features

Media dry, lubricated, unlubricated and 50 µm filtered compressed air or non-corrosive gases

Supply pressure see chart, min. 10% above outlet pressure

Flow rate see chart, at 7 bar inlet pressure and open outlet

Exhaust same nominal size as on inlet valve, thus same relief capacity

Air consumption without air consumption

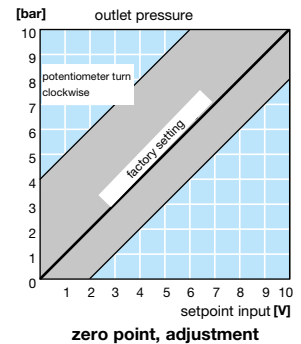
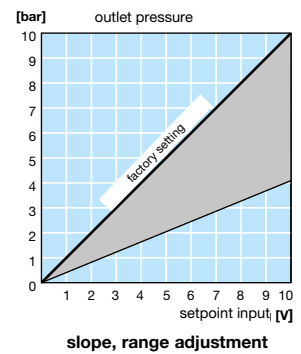
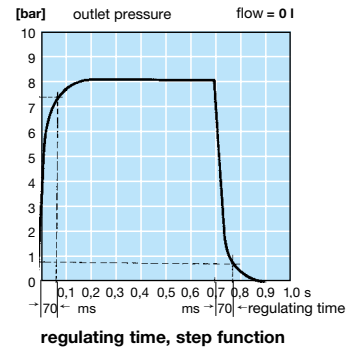

Electrical features

Supply voltage 24 V DC + 15% - 10%, residual ripple max. 10%

Power consumption 12 W at G¹/₈, 22 W at G¹/₄, 30 W at G¹/₂, 44 W at G1

Current consumption 0.5A at G¹/₈, 1.0A at G¹/₄, 1.25A at G¹/₂, 1.7A at G1

Command signal 0 ... 10 V, 0 ... 20 mA, 4 ... 20 mA, digital or Profibus DB rising curve as standard, optionally declining curve

Impedance 100 kΩ at voltage signal (0.1 mA current consumption)
500 Ω at current signal

Electrical connector circular plug according to DIN 43651, 7-pin plug for analogue signal
16-pin plug for digital signal

Accuracy

Linearity/Hysteresis < 1% FS

Response sensitivity < 0.1% FS

Repeatability < 0.1% FS

Over all accuracy ± 0.5%

Regulating time < 1 s over the range, 70 ms at 10 to 90% or 90 to 10% of the range

Adjustment

Zero point calibration ± 10% FS via potentiometer P2

Range calibration + 5% FS or -10% FS via potentiometer P1

Amplification calibration 1:1 up to 1:10 via potentiometer P7

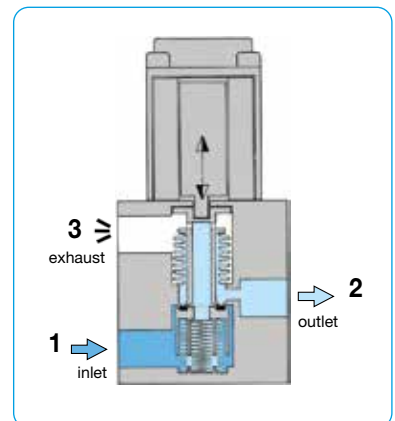
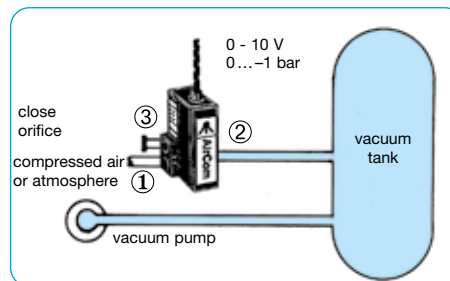
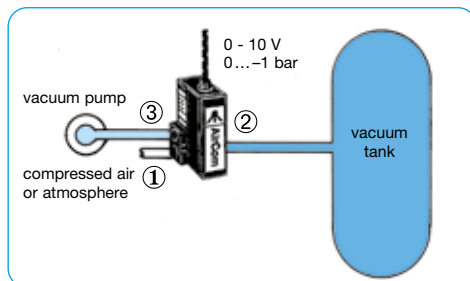

The vacuum pump saves energy and it is easy to fill the tank either with vacuum or pressure. A filter is recommended at orifice ①.

Upstream installation is preferred if rapid evacuation of a tank or system is required. A filter is recommended at orifice ①.

Technical features

• Pressure range	0...-1.0 bar to 0... 1.0 bar	• Linearity / Hysteresis	< 1% FS
• Command signal	0... 10 V, 0... 20 mA, 4... 20 mA, digital	• Response sensitivity	± 0,5% FS
• Feedback signal	0... 10 V, 0... 20 mA, 4... 20 mA	• Repeatability	± 0,5% FS
• Adjustment	zero point, range and amplification	• Regulating time	< 1 s
• Pressure sensors	100 / 500 mbar, 1 bar	• Power consumption	12 / 22 / 30 / 44 W
• Flow rate	250 / 820 / 1700 / 6500 l/min	• Exhaust	full nominal size

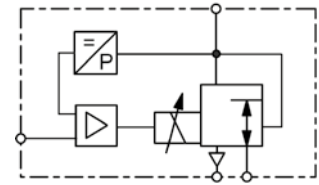

G¹/₈ up to G1
0... 100 mbar/50 bar

Dimensions			Nominal size	K _v -value	Flow rate	Supply max.	Connection thread	Pressure range	Order number
A	B	C	DN	(m³/h)	l/min*1	bar	G	bar	
mm	mm	mm							

Proportional pressure valve										0-10 V input signal, supply voltage 24 V DC, with coupling socket	PR
35	80	63	3	0.18	210	-1	G ¹ / ₈	0...-1.0	PRA00-00V1		
						-1		0...-0.5	PRA00-00V1A5		
						-1		0...-0.1	PRA00-00V1A1		
						3		-1.0... 1.0	PRA00-01V1		
						1		0... 0.1	PRA00-A100		
						2		0... 0.5	PRA00-A500		
						2		0... 1.0	PRA00-0100		
52	105	74	6	0.6	700	-1	G ¹ / ₄	0...-1.0	PR000-00V1		
						-1		0...-0.5	PR000-00V1A5		
						-1		0...-0.1	PR000-00V1A1		
						3		-1.0... 1.0	PR000-01V1		
						1		0... 0.1	PR000-A100		
						2		0... 0.5	PR000-A500		
						2		0... 1.0	PR000-0100		
70	150	101	12	1.2	1400	-1	G ¹ / ₂	0...-1.0	PR100-00V1		
						2		0... 1.0	PR100-0100		
96	190	115	20	4.8	5600	-1	G1	0...-1.0	PR200-00V1		
						2		0... 1.0	PR200-0100		



PRA



PR000-0100



example: combination PR with booster

Special options, add the appropriate letter or number

input signal	0-20 mA 4-20 mA 8 bit digital with hold function Profibus DP			PR...1-.... PR...2-.... PR...3-.... PR...8-....
feedback signal	0-10 V 0-20 mA 4-20 mA		from G ¹ / ₄ on	PR...1-.... PR...2-.... PR...3-....
external feedback signal	0-10 V 0-20 mA 4-20 mA			PR...4-.... PR...5-.... PR...6-....
deviant pressure range for vacuum	indicate on order Bypass version		G ¹ / ₈ and G ¹ / ₄ G ¹ / ₂ G1	PR...-XX.. PR...-..V2 PR1...-..V2 PR2...-..V2 PR...-..0A PR...-..06
for absolute pressure protection class IP65	special cable box, PRK-IP65			PR...-..SS PR...-..19 PR...-..15
body made of stainless steel	valve body and inner parts, 1.4304, EPDM seals, G ¹ / ₄ and G ¹ / ₂			
body made of aluminium for oxygen	nly valve body, max. 20 bar specially cleaned, FKM elastomer		G ¹ / ₄ only	

Accessories, enclosed

coupling socket	7-pin with 2 m cable 7-pin with 5 m cable 7-pin with 2 m cable, IP65 7-pin with 2 m cable 7-pin with 5 m cable	straight straight straight angular angular	PRK-A2L PRK-A5L PRK-I2L PRK-C2L PRK-C5L
other cable length	e.g. 10 m available		

*1 at 6 bar supply pressure and 5 bar outlet pressure

Technical details: see previous page

PDF CAD
www.aircom.net



Order example:
PRA00-00V1



PRK-A

PRK-C

DIMENSIONS AND CONNECTION DIAGRAM "AIRTRONIC"®

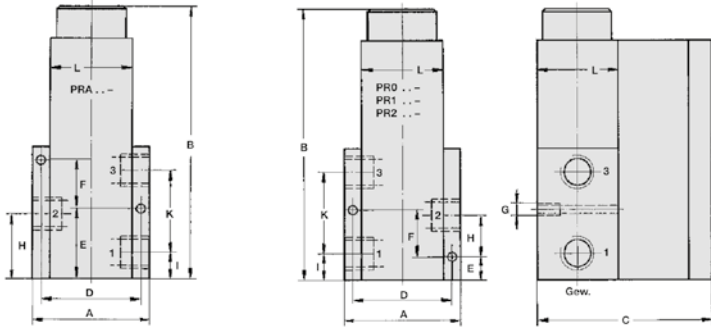

Proport. regulator	thread	A	B	C	D	E
PRA ...	G 1/8	35	80	63	29	18
PRO ...	G 1/4	52	105	74	43	10
PR1 ...	G 1/2	70	150	101	57.5	12
PR2 ...	G 1	96	190	115	79	15

Proport. regulator	F	G	H	I	K	L
PRA ...	7	M 4	15	10	16.6	25
PRO ...	20	M 4	16	11*	34	36
PR1 ...	28	M 6	23	15	48.5	45
PR2 ...	33	M 8	30	20	60	60

* 14 mm from 30 bar pressure range on

"AIRTRONIC"® PROPORTIONAL PRESSURE REGULATOR WITH INTEGRATED PCB

"AirTronic" proportional pressure regulator with integrated PCB

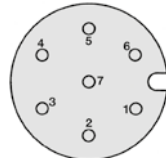
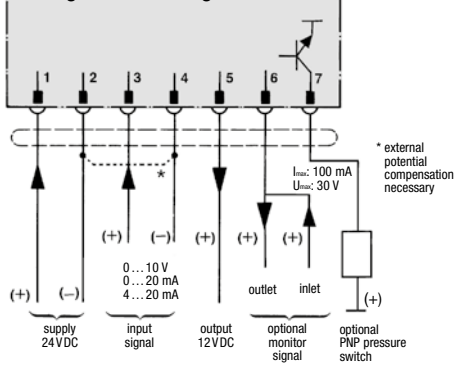

colour of wire		
pin	4-wire	7-wire
1	white	grey
2	brown	blue
3	yellow	yellow
4	green	green
5	-	brown
6	-	white
7	-	pink

pin numbers seen from solder pin side

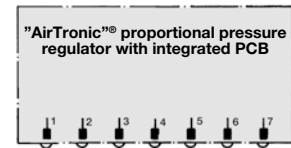

* external potential compensation necessary
potentiometer for adjusting the pressure range

"AIRTRONIC"® CONNECTION DIAGRAM

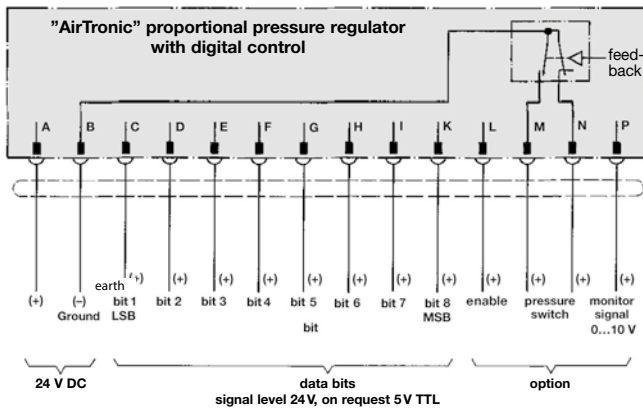

CONNECTION DIAGRAM FOR DIGITALLY CONTROLLED PROPORTIONAL PRESSURE REGULATOR

CONNECTION DIAGRAM WITH POTENTIOMETER

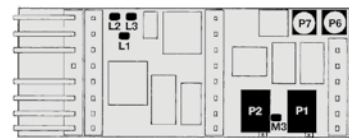

- P1 range: -10%...+5%
- P2 zero point: ± 10%
- P6 option pressure switch: 5...15%
- P7 proportional amplification: 1...11
- M3 measuring point offset zero
- L1 earth (GND)
- L2 solenoid +24 V
- L3 solenoid (pulse width modulation) PWM

ADJUSTMENT OF THE PROPORTIONAL REGULATOR

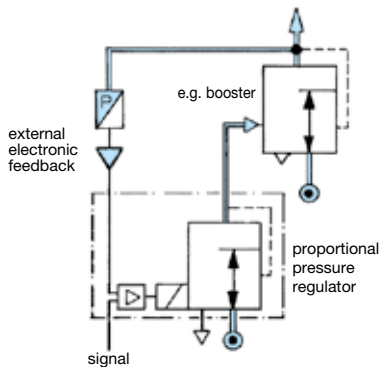

EXTERNAL ELECTRONIC FEEDBACK
0 ... 10 V or 0/4 ... 20 mA

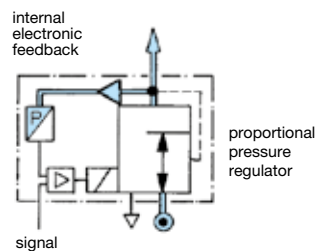

INTERNAL ELECTRONIC FEEDBACK
as standard